

















500x750 HORIZONTAL SHI 41x1,3

	 0°	 45°	 60°	 45°	 60°	
	500	500	330	500	300	x
	400*	280*	200*	280*	190*	x
	750x480	500x480	330x480	500x480	300x480	750x450
						
3x400V 50 Hz	5,5	20-100	6500x41x1,3	2035		
Lmin	Lmax	B	Hmin	Hmax	V	
3100	3600	1760	2210	2400	815	



OPTION
STANDARD

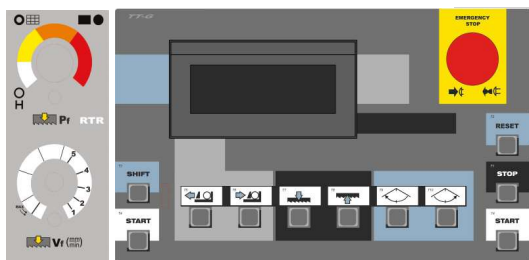
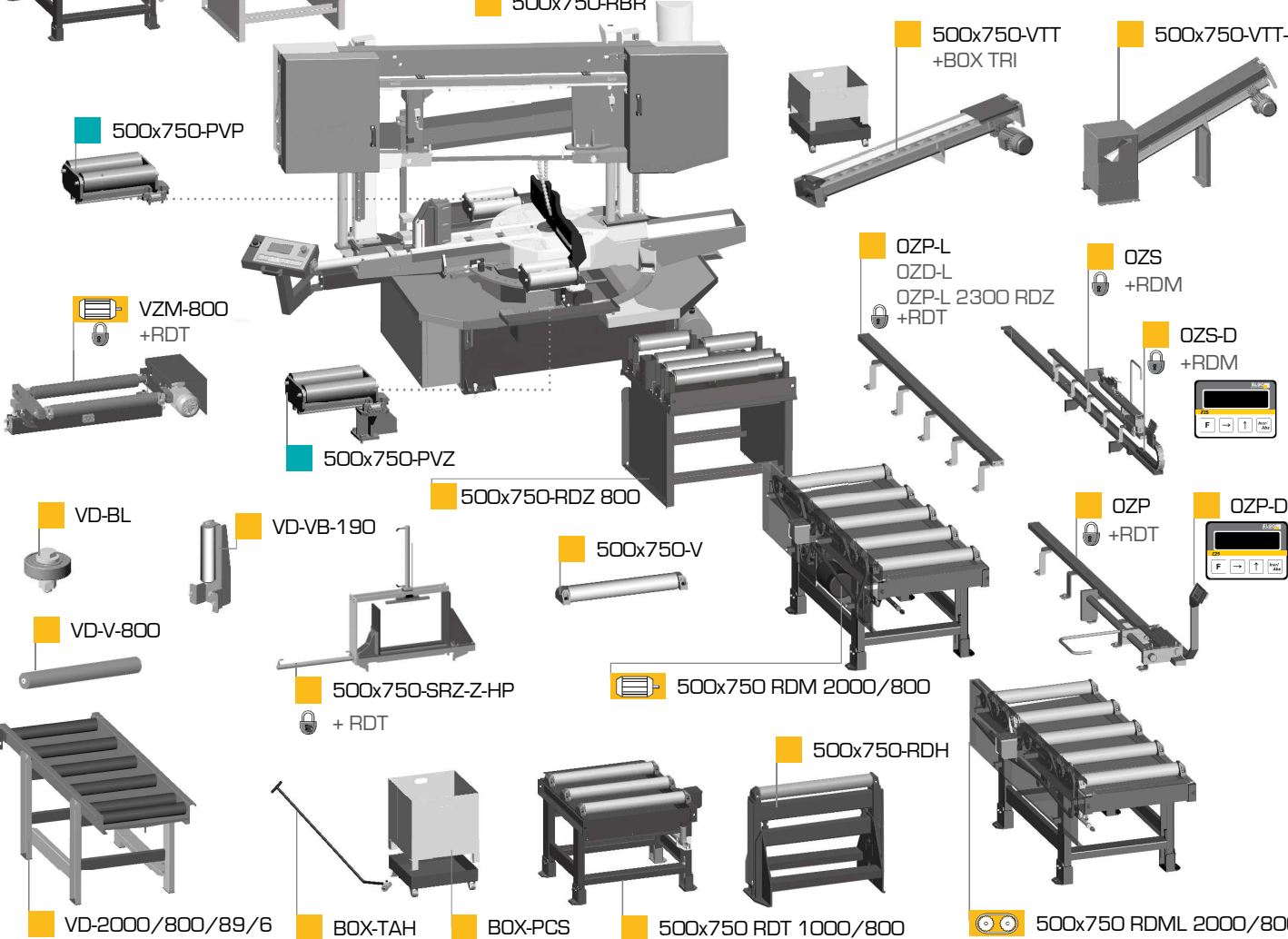
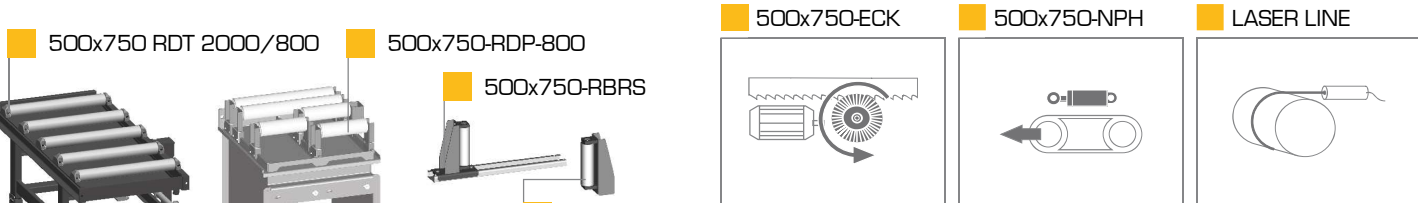
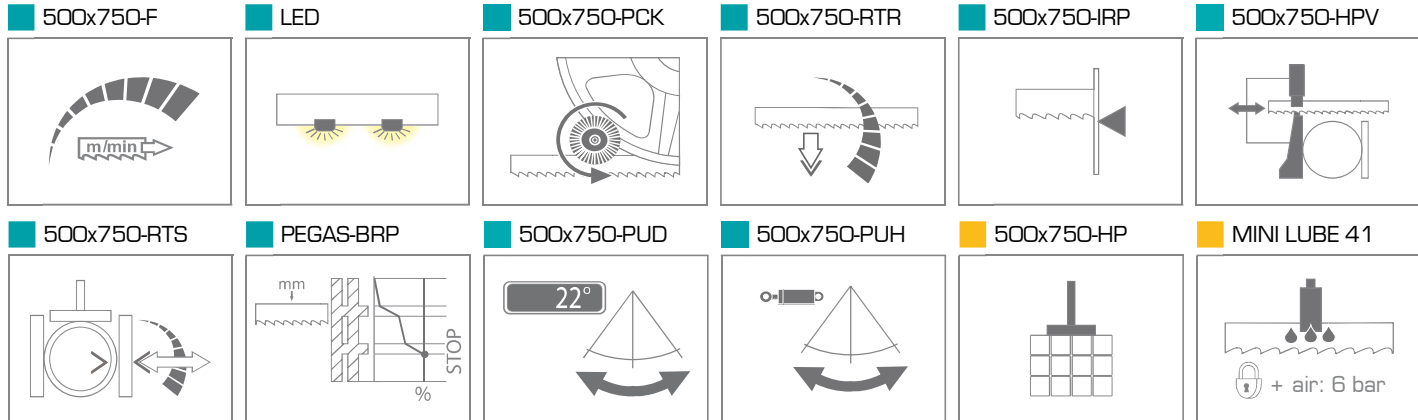

500x750 HORIZONTAL SHI

- výrobce si vyhrazuje právo provádět změny
technických údajů, technické údaje odpovídají 1.1.2020
/ producer has the right to make changes of technical data,
technical data are valid on 1.1.2020

- pila na fotografii není vždy v základním provedení,
uvedené rozměry odpovídají stroji v základním provedení
/ the machine in the picture is not always in the basic version,
mentioned diameters are for machine in basic version

* doporučená hodnota. Při překročení doporučeného
maximálního průměru není možné garantovat výkon
pilového pásu!
/ recommended value. The blade performance cannot
be guaranteed
when the recommended diameter is exceeded!

- řezání svazků bez horního přitlačku
/ cutting of the bundle without top clamping

RTR CONTROL PANEL: MITSUBISHI



PEGAS - GONDA s.r.o.
Čs.armády 322, 684 01 Slavkov u Brna,
CZECH REPUBLIC

www.pegas-gonda.cz
00420-544 221 125 (126) | pegas@gonda.cz